



POWER SUPPLY

- AC 100-240V Wide-range Input
- Active PFC
- Width only 59mm
- Efficiency up to 95.3%
- Safe Hiccup^{PLUS} Overload Mode
- Full Power Between -25°C and +55°C
- DC-OK Relay Contact
- 3 Year Warranty

PRODUCT DESCRIPTION

These PIANO series units are extraordinarily compact, industrial grade power supplies that focus on the essential features needed in today's industrial applications. The excellent cost/performance ratio presents many new and exciting opportunities without compromising quality or reliability.

The unit is equipped with a wide-range input voltage stage, many safety approvals and a wide operational temperature range, which makes the unit applicable for global use.

The addition of a DC-OK signal makes the unit suitable for many industry applications such as process control, factory automation or many other critical applications, where preventive function monitoring can help to avoid long downtimes.

SHORT-FORM DATA

Output voltage	DC 24V	Nominal
Adjustment range	24 – 28V	Factory setting 24.1V
Output current	20.0 – 17.1A	Below +55°C ambient
	12.5 – 10.7A	At +70°C ambient
	Derate linearly between +55°C and +70°C	
Input voltage AC	AC 100-240V	±10%
Mains frequency	50-60Hz	±6%
AC Input current	4.3 / 2.3A	At 120 / 230Vac
Power factor	0.99 / 0.97	At 120 / 230Vac
AC Inrush current	15 / 35A pk	At 120 / 230Vac, 40°C, cold start
Efficiency	94.2 / 95.3%	At 120 / 230Vac
Losses	29.6 / 23.7W	At 120 / 230Vac
Hold-up time	27 / 27ms	At 120 / 230Vac
Temperature range	-25 to +70°C	
Size (WxHxD)	59x124x127mm	
Weight	810g / 1.97lb	

ORDER NUMBERS

Order number:
Power Supply **PIC480.241D**

MAIN APPROVALS

For details or a complete approval list see chapter 19.

IECEE
CB SCHEME
IEC 62368-1
IEC 61010-1 (planned)
IEC 61010-2-201 (planned)

UL US LISTED
IND. CONT. EQ.
(planned)



INDEX



	Page		Page
1. Intended Use	3	18. Dielectric Strength.....	15
2. Installation Instructions	4	19. Approvals and Fulfilled Standards.....	16
3. AC-Input.....	5	20. Regulatory Compliance.....	16
4. DC-Input.....	6	21. Physical Dimensions and Weight	17
5. Input Inrush Current	6	22. Accessory.....	18
6. Output	7	22.1. YR40.242 Redundancy Module	18
7. Hold-up Time.....	8	22.2. PIRD20.241 Redundancy Module.....	18
8. DC-OK Relay Contact	8	22.3. UF20.241 Buffer module	18
9. Efficiency and Power Losses.....	9	23. Application Notes.....	19
10. Functional Diagram.....	10	23.1. Charging of Batteries	19
11. Front Side and User Elements.....	10	23.2. Series Operation	19
12. Connection Terminals	11	23.3. Parallel Use to Increase Output Power....	19
13. Lifetime Expectancy	11	23.4. Parallel Use for 1+1 Redundancy	19
14. MTBF	11	23.5. Operation on Two Phases	20
15. EMC.....	12	23.6. Use in a Tightly Sealed Enclosure	20
16. Environment.....	13		
17. Safety and Protection Features	14		

The information given in this document is correct to the best of our knowledge and experience at the time of publication. If not expressly agreed otherwise, this information does not represent a warranty in the legal sense of the word. As the state of our knowledge and experience is constantly changing, the information in this data sheet is subject to revision. We therefore kindly ask you to always use the latest issue of this document (available under www.pulspower.com).

No part of this document may be reproduced or utilized in any form without our prior permission in writing.

Packaging and packaging aids can and should always be recycled. The product itself may not be disposed of as domestic refuse.

TERMINOLOGY AND ABBREVIATIONS

PE and  symbol	PE is the abbreviation for Protective Earth and has the same meaning as the symbol  .
Earth, Ground	This document uses the term "earth" which is the same as the U.S. term "ground".
T.b.d.	To be defined, value or description will follow later.
AC 230V	A figure displayed with the AC or DC before the value represents a nominal voltage with standard tolerances included. E.g.: DC 12V describes a 12V battery disregarding whether it is full (13.7V) or flat (10V)
230Vac	A figure with the unit (Vac) at the end is a momentary figure without any additional tolerances included.
50Hz vs. 60Hz	As long as not otherwise stated, AC 100V and AC 230V parameters are valid at 50Hz mains frequency. AC 120V parameters are valid for 60Hz mains frequency.
may	A key word indicating flexibility of choice with no implied preference.
shall	A key word indicating a mandatory requirement.
should	A key word indicating flexibility of choice with a strongly preferred implementation.

1. INTENDED USE

This device is designed for installation in an enclosure and is intended for commercial use, such as in industrial control, process control, monitoring, measurement, Audio/Video, information or communication equipment or the like.

Do not use this device in equipment where malfunction may cause severe personal injury or threaten human life.

Without additional measures to reduce the conducted emissions on the output (e.g. by using a filter), the device is not suited to supply a local DC power network in industrial, residential, commercial and light-industrial environments.

If this device is used in a manner outside of its specification, the protection provided by the device may be impaired.

2. INSTALLATION INSTRUCTIONS

⚠ WARNING Risk of electrical shock, fire, personal injury or death.

- Turn power off before working on the device. Protect against inadvertent re-powering.
- Do not modify or repair the unit.
- Do not open the unit as high voltages are present inside.
- Use caution to prevent any foreign objects from entering the housing.
- Do not use in wet locations or in areas where moisture or condensation can be expected.
- Do not touch during power-on, and immediately after power-off. Hot surfaces may cause burns.

Obey the following installation instructions:

This device may only be installed and put into operation by qualified personnel.

This device does not contain serviceable parts. The tripping of an internal fuse is caused by an internal defect.

If damage or malfunction should occur during installation or operation, immediately turn power off and send unit to the factory for inspection.

Install device in an enclosure providing protection against electrical, mechanical and fire hazards.

Install the device onto a DIN-rail according to EN 60715 with the input terminals on the bottom of the device.

Make sure that the wiring is correct by following all local and national codes. Use appropriate copper cables that are designed for a minimum operating temperature of 60°C for ambient temperatures up to +45°C, 75°C for ambient temperatures up to +55°C and 90°C for ambient temperatures up to +70°C. Ensure that all strands of a stranded wire enter the terminal connection. Unused screw terminals should be securely tightened. Use ferrules for wires on the input terminals.

The device is designed for pollution degree 2 areas in controlled environments. No condensation or frost is allowed.

The enclosure of the device provides a degree of protection of IP20. The enclosure does not provide protection against spilled liquids.

The isolation of the device is designed to withstand impulse voltages of overvoltage category III according to IEC 60664-1.

The device is designed as "Class of Protection" I equipment according to IEC 61140. Do not use without a proper PE (Protective Earth) connection.

The device is suitable to be supplied from TN, TT or IT mains networks. The continuous voltage between the input terminals and the PE potential must not exceed 300Vac.

A disconnecting means shall be provided for the input of the device.

The device is designed for convection cooling and does not require an external fan. Do not obstruct airflow and do not cover ventilation grid!

The device is designed for altitudes up to 5000m (16400ft). Above 2000m (6560ft) the overvoltage category is reduced to level II and a reduction in output current is required.

Keep the following minimum installation clearances: 40mm on top, 20mm on the bottom, 5mm left and right side. Increase the 5mm to 15mm in case the adjacent device is a heat source. When the device is permanently loaded with less than 50%, the 5mm can be reduced to zero.

The device is designed, tested and approved for branch circuits up to 20A without additional protection device. For higher branch circuits use an additional protection device. If an external input protection device is utilized, do not use one smaller than a 10A B- or 6A C-characteristic to avoid a nuisance tripping of the circuit breaker.

The maximum surrounding air temperature is +70°C (+158°F). The operational temperature is the same as the ambient or surrounding air temperature and is defined 2cm below the device.

The device is designed to operate in areas between 5% and 95% relative humidity.

3. AC-INPUT

The device is suitable to be supplied from TN, TT or IT mains networks with AC voltage.

AC input	Nom.	AC 100-240V	
AC input range	Min.	90-264Vac	Continuous operation
	Min.	264-300Vac	Occasionally for maximal 500ms
Allowed voltage L or N to earth	Max.	300Vac	Continuous, according to IEC 60664-1
Input frequency	Nom.	50–60Hz	±6%
Turn-on voltage	Typ.	81Vac	Steady-state value, see Fig. 3-1
Shut-down voltage	Typ.	63Vac / 71Vac	At no load / nominal load, steady-state value, see Fig. 3-1
External input protection	See recommendations in chapter 2.		

		AC 100V	AC 120V	AC 230V	
Input current	Typ.	5.2A	4.3A	2.3A	At 24V, 20A, see Fig. 3-3
Power factor	Typ.	0.99	0.99	0.97	At 24V, 20A, see Fig. 3-4
Crest factor	Typ.	1.6	1.7	2.0	At 24V, 20A, The crest factor is the mathematical ratio of the peak value to RMS value of the input current waveform.
Start-up delay	Typ.	420ms	300ms	230ms	See Fig. 3-2
Rise time	Typ.	100ms	100ms	100ms	At 24V, 20A const. current load, 0mF load capacitance, see Fig. 3-2
	Typ.	140ms	140ms	140ms	At 24V, 20A const. current load, 20mF load capacitance, see Fig. 3-2
Turn-on overshoot	Max.	200mV	200mV	200mV	See Fig. 3-2

Fig. 3-1 Input voltage range, typ.

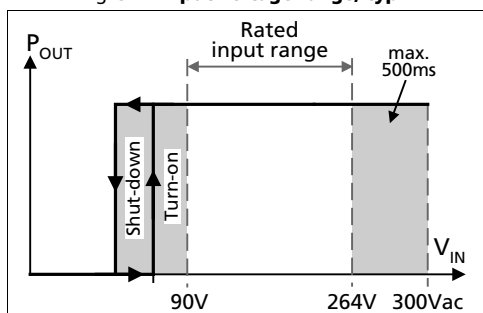

Fig. 3-2 Turn-on behavior, definitions

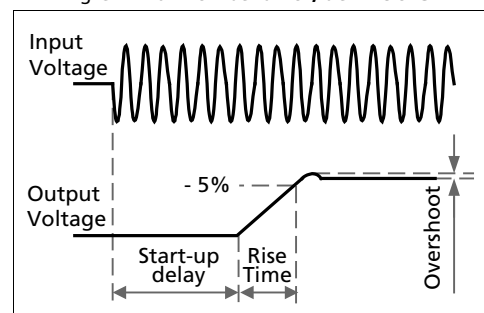

Fig. 3-3 Input current vs. output load at 24V

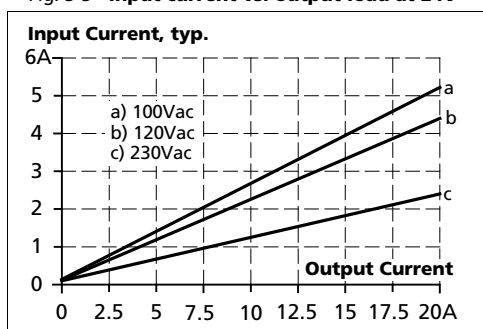
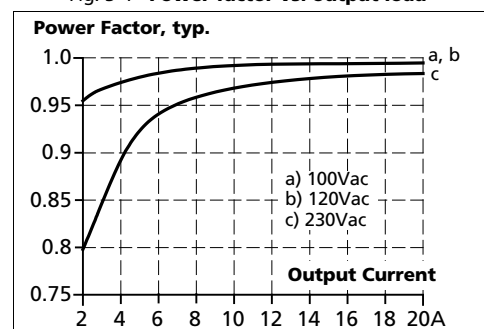

Fig. 3-4 Power factor vs. output load



4. DC-INPUT

Do not operate this power supply with DC-input voltage.

5. INPUT INRUSH CURRENT

An active inrush limitation circuit (NTCs, which are bypassed by a relay contact) limits the input inrush current after turn-on of the input voltage.

The charging current into EMI suppression capacitors is disregarded in the first microseconds after switch-on.

		AC 100V	AC 120V	AC 230V	
Inrush current	Max.	15A _{peak}	18A _{peak}	42A _{peak}	At 40°C, cold start
	Typ.	13A _{peak}	13A _{peak}	25A _{peak}	At 25°C, cold start
	Typ.	13A _{peak}	15A _{peak}	35A _{peak}	At 40°C, cold start
Inrush energy	Max.	3A ² s	3A ² s	3A ² s	At 40°C, cold start

Fig. 5-1 Typical turn-on behaviour at nominal load, 120Vac input and 25°C ambient

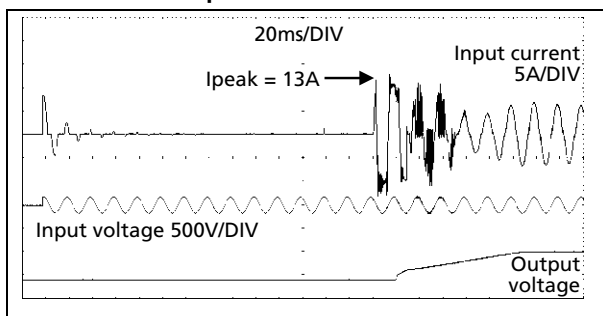
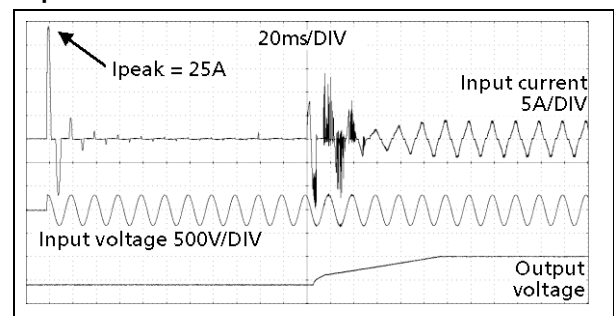

Fig. 5-2 Typical turn-on behaviour at nominal load, 230Vac input and 25°C ambient



6. OUTPUT

The output provides a SELV/PELV rated voltage, which is galvanically isolated from the input voltage.

The output is designed to supply any kind of loads, including capacitive and inductive loads. If extreme large capacitors, such as EDLCs (electric double layer capacitors or "UltraCaps") with a capacitance > 3F are connected to the output, the unit might charge the capacitor in an intermittent mode.

The output is electronically protected against overload, no-load and short-circuits. In case of a protection event, audible noise may occur.

Output voltage	Nom.	DC 24V	
Adjustment range	Min.	24-28V	Guaranteed value
	Max.	30V	This is the maximum output voltage which can occur at the clockwise end position of the potentiometer due to tolerances. It is not a guaranteed value which can be achieved.
Factory settings	Typ.	24.1V	±0.2%, at full load and cold unit
Line regulation	Max.	10mV	Between 90 and 300Vac
Load regulation	Max.	100mV	Between 0A and 20A, static value, see Fig. 6-1
Ripple and noise voltage	Max.	100mVpp	Bandwidth 20Hz to 20MHz, 50Ohm
Output current	Nom.	20.0A	At 24V and an ambient temperature below 55°C
	Nom.	12.5A	At 24V and 70°C ambient temperature
	Nom.	17.1A	At 28V and an ambient temperature below 55°C
	Nom.	10.7A	At 28V and 70°C ambient temperature
		Derate linearly between +55°C and +70°	
Overload behaviour	Continuous current		For output voltage above 13Vdc, see Fig. 6-1
	Intermittent current ¹⁾		For output voltage below 13Vdc, see Fig. 6-1
Overload/ short-circuit current	Max.	27.5A	Continuous current, see Fig. 6-1
	Typ.	30A	Intermittent current peak value for typ. 1s Load impedance 50mOhm, see Fig. 6-2 Discharge current of output capacitors is not included.
	Max.	11A	Intermittent current average value (R.M.S.) Load impedance 50mOhm, see Fig. 6-2
Output capacitance	Typ.	6 800µF	Included inside the power supply
Back-feeding loads	Max.	35V	The unit is resistant and does not show malfunctioning when a load feeds back voltage to the power supply. It does not matter whether the power supply is on or off. The absorbing energy can be calculated according to the built-in large sized output capacitor.

1) At heavy overloads (when output voltage falls below 13V), the power supply delivers continuous output current for 2-5s. After this, the output is switched off for approx. 7s before a new start attempt with duration of 1s is automatically performed. This cycle is repeated as long as the overload exists. If the overload has been cleared, the device will operate normally.

Fig. 6-1 Output voltage vs. output current, typ.

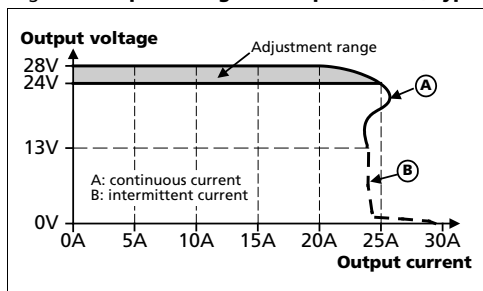
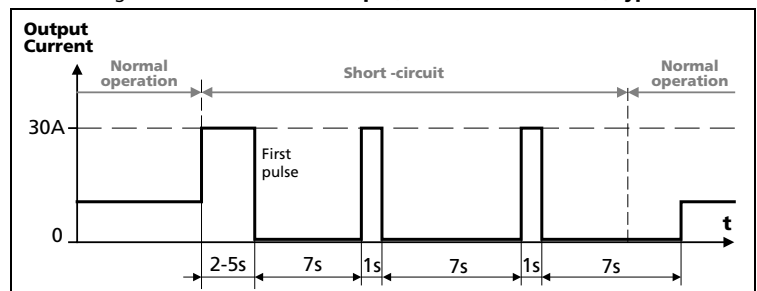

Fig. 6-2 Short-circuit on output, intermittent current, typ.



7. HOLD-UP TIME

The hold-up time is the time during which a power supply's output voltage remains within specification following the loss of input power. The hold-up time is output load dependent. At no load, the hold-up time can be up to several seconds. The green DC-ok lamp is also on during this time.

		AC 100V	AC 120V	AC 230V	
Hold-up Time	typ.	54ms	54ms	54ms	At 24V, 10A, see Fig. 7-1
	min.	44ms	44ms	44ms	At 24V, 10A, see Fig. 7-1
	typ.	27ms	27ms	27ms	At 24V, 20A, see Fig. 7-1
	min.	22ms	22ms	22ms	At 24V, 20A, see Fig. 7-1

Fig. 7-1 Hold-up time vs. input voltage

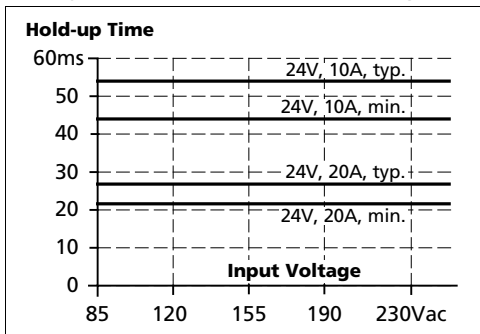
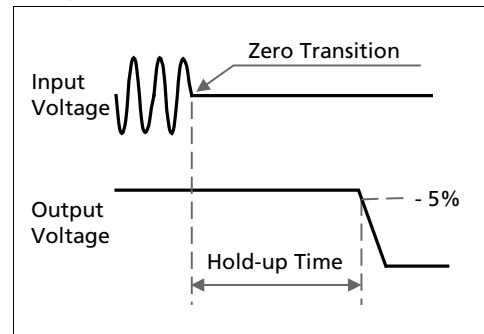

Fig. 7-2 Shut-down behavior, definitions



8. DC-OK RELAY CONTACT

This feature monitors the output voltage on the output terminals of a running power supply.

Contact closes	As soon as the output voltage reaches 22V.
Contact opens	As soon as the output voltage falls below 22V.
Switching hysteresis	Typically 0.3V
Contact ratings	Maximal 60Vdc 0.3A, 30Vdc 1A, 30Vac 0.5A, resistive load Minimal permissible load: 1mA at 5Vdc
Isolation voltage	See dielectric strength table in section 18.

Fig. 8-1 DC-ok relay contact behavior

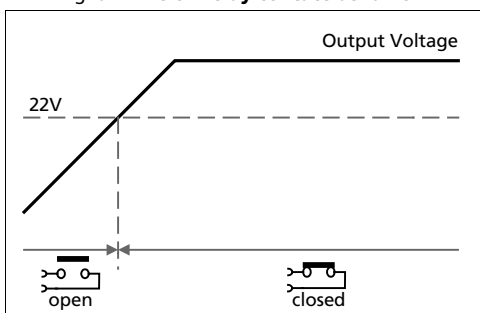

9. EFFICIENCY AND POWER LOSSES

		AC 100V	AC 120V	AC 230V	
Efficiency	Typ.	93.6%	94.2%	95.3%	At 24V, 20A
Average efficiency*)	Typ.	93.4%	93.8%	94.5%	25% at 5A, 25% at 10A, 25% at 15A, 25% at 20A
Power losses	Typ.	5.7W	4.6W	3.5W	At 24V, 0A
	Typ.	15.6W	14.8W	13.2W	At 24V, 10A
	Typ.	32.8W	29.6W	23.7W	At 24V, 20A

*) The average efficiency is an assumption for a typical application where the power supply is loaded with 25% of the nominal load for 25% of the time, 50% of the nominal load for another 25% of the time, 75% of the nominal load for another 25% of the time and with 100% of the nominal load for the rest of the time.

Fig. 9-1 Efficiency vs. output current at 24V, typ.

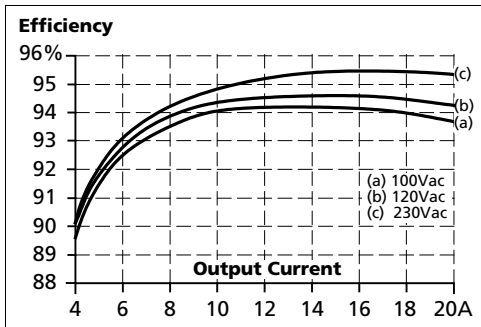

Fig. 9-2 Losses vs. output current at 24V, typ.

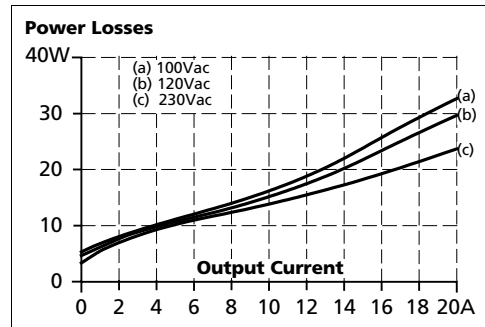

Fig. 9-3 Efficiency vs. input voltage at 24V, 20A, typ.

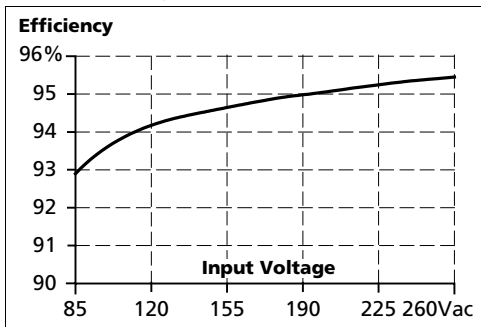
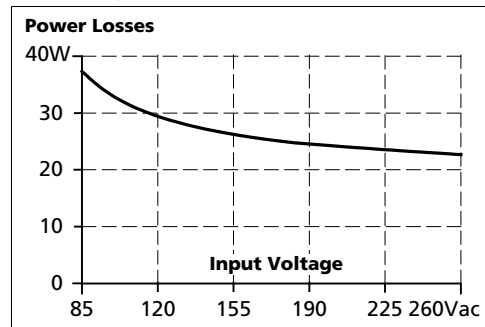
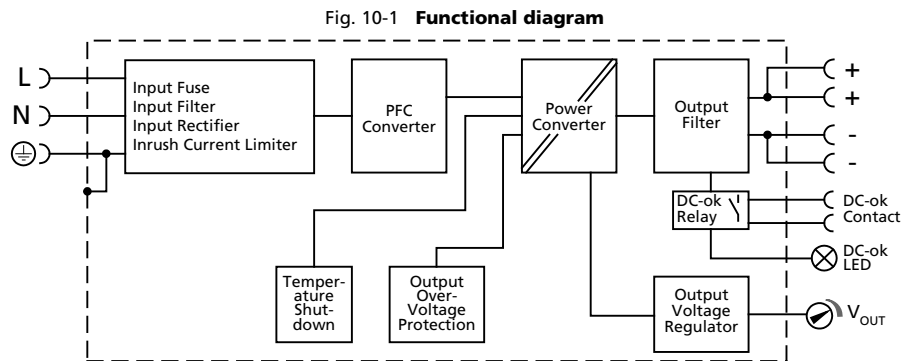

Fig. 9-4 Losses vs. input voltage at 24V, 20A, typ.



10. FUNCTIONAL DIAGRAM



11. FRONT SIDE AND USER ELEMENTS

Fig. 11-1 **Front side**



A Input Terminals

- N, L** Line input
- PE (Protective Earth) input

B Output Terminals

- Two identical + poles and two identical - poles
- +** Positive output
- Negative (return) output

C DC-OK LED (green)

On, when the output voltage is above 18V.

D Output Voltage Adjustment Potentiometer

E DC-OK Relay Contact

The DC-OK relay contact is not synchronized with the DC-OK LED. See chapter 8 for details.

12. CONNECTION TERMINALS

The terminals are IP20 finger safe constructed and suitable for field- and factory wiring.

	Input	Output	DC-OK-Signal
Type	Screw termination	Screw termination	Push-in termination
Solid wire	Max. 6mm ²	Max. 6mm ²	Max. 1.5mm ²
Stranded wire	Max. 4mm ²	Max. 4mm ²	Max. 1.5mm ²
American Wire Gauge	AWG 20-10	AWG 20-10	AWG 24-16
Max. wire diameter (including ferrules)	2.8mm	2.8mm	1.6mm
Recommended tightening torque	Max. 1Nm, 9lb-in	Max. 1Nm, 9lb-in	-
Wire stripping length	7mm / 0.28inch	7mm / 0.28inch	7mm / 0.28inch
Screwdriver	3.5mm slotted or cross-head No 2	3.5mm slotted or cross-head No 2	3mm slotted to open the spring

13. LIFETIME EXPECTANCY

The Lifetime expectancy shown in the table indicates the minimum operating hours (service life) and is determined by the lifetime expectancy of the built-in electrolytic capacitors. Lifetime expectancy is specified in operational hours and is calculated according to the capacitor's manufacturer specification. The manufacturer of the electrolytic capacitors only guarantees a maximum life of up to 15 years (131 400h). Any number exceeding this value is a calculated theoretical lifetime which can be used to compare devices.

	AC 100V	AC 120V	AC 230V	
Lifetime expectancy	72 000h	79 000h	102 000h	At 24V, 20A and 40°C
	167 000h	171 000h	197 000h	At 24V, 10A and 40°C
	203 000h	223 000h	288 000h	At 24V, 20A and 25°C
	472 000h	485 000h	557 000h	At 24V, 10A and 25°C

14. MTBF

MTBF stands for **Mean Time Between Failure**, which is calculated according to statistical device failures, and indicates reliability of a device. It is the statistical representation of the likelihood of a unit to fail and does not necessarily represent the life of a product.

The MTBF figure is a statistical representation of the likelihood of a device to fail. A MTBF figure of e.g. 1 000 000h means that statistically one unit will fail every 100 hours if 10 000 units are installed in the field. However, it can not be determined if the failed unit has been running for 50 000h or only for 100h.

For these types of units the MTTF (**Mean Time To Failure**) value is the same value as the MTBF value.

	AC 100V	AC 120V	AC 230V	
MTBF SN 29500, IEC 61709	595 000h	611 000h	704 000h	At 24V, 20A and 40°C
	1 090 000h	1 116 000h	1 252 000h	At 24V, 20A and 25°C
MTBF MIL HDBK 217F	274 000h	275 000h	289 000h	At 24V, 20A and 40°C, Ground Benign GB40
	368 000h	370 000h	386 000h	At 24V, 20A and 25°C, Ground Benign GB25
	59 000h	59 000h	63 000h	At 24V, 20A and 40°C, Ground Fixed GF40
	76 000h	76 000h	80 000h	At 24V, 20A and 25°C, Ground Fixed GF25

15. EMC

The EMC behavior of the device is designed for applications in industrial environment as well as in residential, commercial and light industry environments.

The device complies with EN 61000-6-1, EN 61000-6-2, EN 61000-6-3, EN 61000-6-4, EN 61000-3-2 and EN 61000-3-3.

Without additional measures to reduce the conducted emissions on the output (e.g. by using a filter), the device is not suited to supply a local DC power network in industrial, residential, commercial and light-industrial environments.

EMC Immunity

Electrostatic discharge	EN 61000-4-2	Contact discharge	8kV	Criterion A
		Air discharge	8kV	Criterion A
Electromagnetic RF field	EN 61000-4-3	80MHz-2.7GHz	20V/m	Criterion A
Fast transients (Burst)	EN 61000-4-4	Input lines	4kV	Criterion A
		Output lines	2kV	Criterion A
		DC-OK signal (coupling clamp)	2kV	Criterion A
Surge voltage on input	EN 61000-4-5	L → N	2kV	Criterion A
		L → PE, N → PE	4kV	Criterion A
Surge voltage on output	EN 61000-4-5	+ → -	1kV	Criterion A
		+ / - → PE	2kV	Criterion A
Surge voltage on DC-OK	EN 61000-4-5	DC-OK signal → PE	1kV	Criterion A
Conducted disturbance	EN 61000-4-6	0.15-80MHz	20V	Criterion A
Mains voltage dips	EN 61000-4-11	0% of 100Vac	0Vac, 20ms	Criterion A
		40% of 100Vac	40Vac, 200ms	Criterion C
		70% of 100Vac	70Vac, 500ms	Criterion A
		0% of 200Vac	0Vac, 20ms	Criterion A
		40% of 200Vac	80Vac, 200ms	Criterion A
		70% of 200Vac	140Vac, 500ms	Criterion A
Voltage interruptions	EN 61000-4-11	0V	5000ms	Criterion C
Powerful transients	VDE 0160	Over entire load range	750V, 0.3ms	Criterion A

Performance criterions:

A: The device shows normal operation behavior within the defined limits.

C: Temporary loss of function is possible. The device may shut-down and restarts by itself. No damage or hazards for the device will occur.

EMC Emission

Conducted emission input lines	EN 55011, EN 55022, FCC Part 15, CISPR 11, CISPR 22	Class B
Conducted emission output lines	IEC/CISPR 16-1-2, IEC/CISPR 16-2-1	Limits for DC power port acc. EN 61000-6-3 not fulfilled
Radiated emission	EN 55011, EN 55022	Class B
Harmonic input current	EN 61000-3-2	Fulfilled, Class A limits
Voltage fluctuations, flicker	EN 61000-3-3	Fulfilled tested with constant current loads, non pulsing

This device complies with FCC Part 15 rules.

Operation is subjected to following two conditions: (1) this device may not cause harmful interference, and (2) this device must accept any interference received, including interference that may cause undesired operation.

Switching frequencies:

PFC converter	80kHz to 130kHz	Input voltage and load dependent
Main converter	75kHz to 180kHz	Output voltage and load dependent
Auxiliary converter	60kHz	Fixed frequency

16. ENVIRONMENT

Operational temperature	-25°C to +70°C (-13°F to 158°F)	Operational temperature is the same as the ambient or surrounding temperature and is defined as the air temperature 2cm below the unit.
Storage temperature	-40°C to +85°C (-40°F to 185°F)	For storage and transportation
Output de-rating	12W/°C 30W/1000m or 5°C/1000m The de-rating is not hardware controlled. The user has to take this into consideration to stay below the de-rated current limits in order not to overload the unit.	Between +55°C and +70°C (131°F to 140°F) For altitudes >2000m (6560ft), see Fig. 16-2
Humidity	5 to 95% r.h.	According to IEC 60068-2-30
Atmospheric pressure	110-54kPa	See Fig. 16-2 for details
Altitude	Up to 5000m (16 400ft)	See Fig. 16-2 for details
Over-voltage category	II	According to IEC 60664-1, for altitudes up to 5000m
Impulse withstand voltages	4kV (according to over-voltage category III)	Input to PE According to IEC 60664-1, for altitudes up to 2000m
Degree of pollution	2	According to IEC 60664-1, not conductive
Vibration sinusoidal	2-17.8Hz: ±1.6mm; 17.8-500Hz: 2g 2 hours / axis	According to IEC 60068-2-6
Shock	30g 6ms, 20g 11ms 3 bumps per direction, 18 bumps in total Shock and vibration is tested in combination with DIN-Rails according to EN 60715 with a height of 15mm and a thickness of 1.3mm and standard orientation.	According to IEC 60068-2-27
LABS compatibility	As a rule, only non-silicon precipitating materials are used. The unit conforms to the LABS criteria and is suitable for use in paint shops.	
Corrosive gases	Tested according to ISA-71.04-1985, Severity Level G3 and IEC 60068-2-60 Test Ke Method 4 for a service life of minimum 10years in these environments.	
Audible noise	Some audible noise may be emitted from the power supply during no load, overload or short circuit.	

Fig. 16-1 Output current vs. ambient temp.

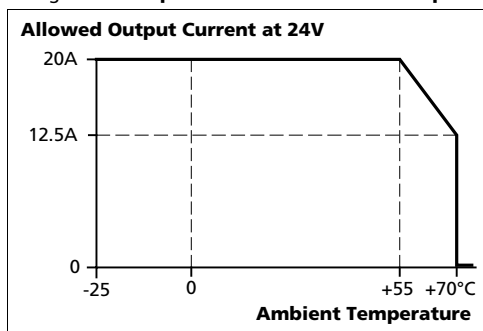
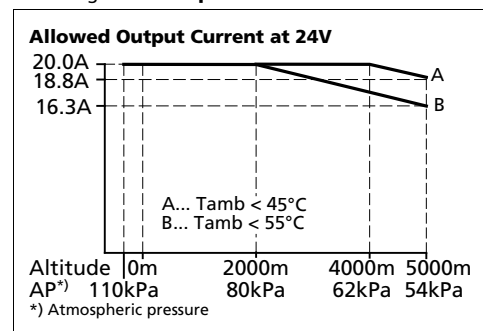

Fig. 16-2 Output current vs. altitude



17. SAFETY AND PROTECTION FEATURES

Isolation resistance	Min.	500MΩ	At delivered condition between input and output, measured with 500Vdc
	Min.	500MΩ	At delivered condition between input and PE, measured with 500Vdc
	Min.	500MΩ	At delivered condition between output and PE, measured with 500Vdc
	Min.	500MΩ	At delivered condition between output and DC-OK contacts, measured with 500Vdc
PE resistance	Max.	0.1Ω	Resistance between PE terminal and the housing in the area of the DIN-rail mounting bracket.
Output over-voltage protection	Typ.	30.5Vdc	In case of an internal defect, a redundant circuit limits the maximum output voltage. The output shuts down and automatically attempts to restart.
	Max.	32.0Vdc	
Class of protection		I	According to IEC 61140 A PE (Protective Earth) connection is required
Ingress protection		IP 20	According to EN/IEC 60529
Over-temperature protection		Included	Output shut-down with automatic restart. Temperature sensors are installed on critical components inside the unit and turn the unit off in safety critical situations, which can happen e.g. when ambient temperature is too high, ventilation is obstructed or the de-rating requirements are not followed. There is no correlation between the operating temperature and turn-off temperature since this is dependent on input voltage, load and installation methods.
Input transient protection		MOV (Metal Oxide Varistor)	For protection values see chapter 15 (EMC).
Internal input fuse		Included	Not user replaceable slow-blow high-braking capacity fuse
Touch current (leakage current)	Typ.	0.12mA / 0.30mA	At 100Vac, 50Hz, TN-,TT-mains / IT-mains
	Typ.	0.17mA / 0.45mA	At 120Vac, 60Hz, TN-,TT-mains / IT-mains
	Typ.	0.27mA / 0.71mA	At 230Vac, 50Hz, TN-,TT-mains / IT-mains
	Max.	0.15mA / 0.38mA	At 110Vac, 50Hz, TN-,TT-mains / IT-mains
	Max.	0.21mA / 0.56mA	At 132Vac, 60Hz, TN-,TT-mains / IT-mains
	Max.	0.35mA / 0.91mA	At 264Vac, 50Hz, TN-,TT-mains / IT-mains

18. DIELECTRIC STRENGTH

The output voltage is floating and has no ohmic connection to the ground.

The output is insulated to the input by a double or reinforced insulation.

Type and routine tests are conducted by the manufacturer. Field tests may be conducted in the field using the appropriate test equipment which applies the voltage with a slow ramp (2s up and 2s down). Connect all input-terminals together as well as all output poles before conducting the test. When testing, set the cut-off current settings to the value in the table below.

We recommend that either the + pole or the - pole shall be connected to the protective earth system. This helps to avoid situations in which a load starts unexpectedly or can not be switched off when unnoticed earth faults occur.

Fig. 18-1 Dielectric strength

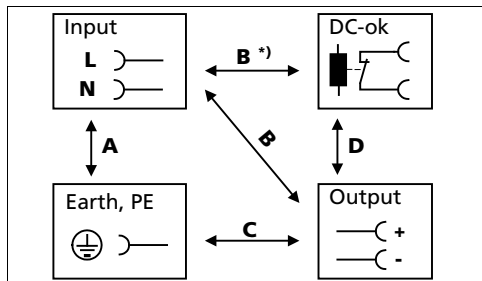



		A	B	C	D
Type test	60s	2500Vac	3000Vac	500Vac	500Vac
Routine test	5s	2500Vac	2500Vac	500Vac	500Vac
Field test	5s	2000Vac	2000Vac	500Vac	500Vac
Field test cut-off current settings		> 10mA	> 10mA	> 20mA	> 1mA





B*)

When testing input to DC-OK ensure that the maximal voltage between DC-OK and the output is not exceeded (column D). We recommend connecting DC-OK pins and the output pins together when performing the test.

19. APPROVALS AND FULFILLED STANDARDS

IEC 61010 (planned)		CB Scheme Certificate IEC 61010-2-201 Electrical Equipment for Measurement, Control and Laboratory Use - Particular requirements for control equipment
IEC 62368		CB Scheme Certificate IEC 62368-1 Audio/video, information and communication technology equipment - Safety requirements Output safety level: ES1
UL 61010-2-201 (former UL 508) (planned)		UL Certificate Listed equipment for category NMTR - UL 61010-2-201 Electrical Equipment for Measurement, Control and Laboratory Use - Particular requirements for control equipment Applicable for US and Canada E-File: E198865

20. REGULATORY COMPLIANCE

CE		EU Declaration of Conformity Trade conformity assessment for Europe The CE mark indicates conformance with the European - RoHS directive, - EMC directive and the - Low-voltage directive (LVD)
REACH Directive		Manufacturer's Statement EU-Regulation regarding the Registration, Evaluation, Authorisation and Restriction of Chemicals
WEEE Directive		Manufacturer's Statement EU-Directive on Waste Electrical and Electronic Equipment
RoHS (China RoHS 2)		Manufacturer's Statement Administrative Measures for the Restriction of the Use of Hazardous Substances in Electrical and Electronic Products 25 years
EAC		EAC Certificate EAC EurAsian Conformity - Registration Russia, Kazakhstan and Belarus

21. PHYSICAL DIMENSIONS AND WEIGHT

Width	59mm 2.32"
Height	124mm 4.88"
Depth	127mm 5.0" The DIN-rail height must be added to the unit depth to calculate the total required installation depth.
Weight	810g / 1.79lb
DIN-Rail	Use 35mm DIN-rails according to EN 60715 or EN 50022 with a height of 7.5 or 15mm.
Housing material	Body: Aluminium alloy Cover: zinc-plated steel
Installation clearances	See chapter 2
Penetration protection	Small parts like screws, nuts, etc. with a diameter larger than 4.5mm

Fig. 21-1 Front view

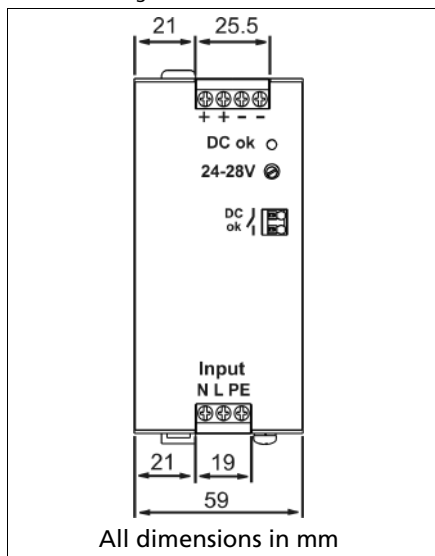
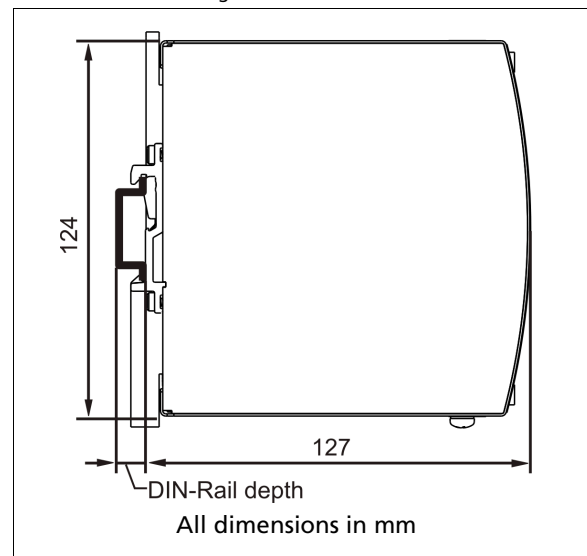

Fig. 21-2 Side view



22. ACCESSORY

22.1. YR40.242 REDUNDANCY MODULE



The YR40.242 is a dual redundancy module, which can be used to build 1+1 or N+1 redundant systems.

The device is equipped with two 20A nominal input channels, which are individually decoupled by utilizing MOSFET technology. The output can be loaded with a nominal 40A continuous current.

Using MOSFETs instead of diodes reduces heat generation, losses and voltage drop between input and output. Due to these advantages, the unit is very narrow and only requires 36mm width on the DIN-rail.

The device does not require an additional auxiliary voltage and is self-powered even in case of a short circuit across the output. It requires suitable power supplies on the input, where the sum of the continuous short circuit current stays below 26A. This is typically achieved when the power supplies are featured with an intermittent overload behavior (Hiccup Mode).

See chapter 23.4 for wiring information.

22.2. PIRD20.241 REDUNDANCY MODULE



The PIRD20.241 is a dual redundancy module, which can be used to build 1+1 or N+1 redundant systems.

The device is equipped with two 10A nominal input channels, which are individually decoupled by utilizing diode technology. The output can be loaded with a nominal 20A continuous current.

The device does not require an additional auxiliary voltage and is self-powered even in case of a short circuit across the output.

The unit is very narrow and only requires 39mm width on the DIN-rail.

See chapter 23.4 for wiring information.

22.3. UF20.241 BUFFER MODULE



The UF20.241 buffer module is a supplementary device for DC 24V power supplies. It delivers power to bridge typical mains failures or extends the hold-up time after the AC power is turned off.

When the power supply provides a sufficient voltage, the buffer module stores energy in the integrated electrolytic capacitors. When the mains voltage is lost, the stored energy is released to the DC-bus in a regulated process.

The buffer module can be added in parallel to the load circuit at any given point and does not require any control wiring.

One buffer module can deliver 20A additional current and can be added in parallel to increase the output ampacity or the hold-up time.

For longer hold-up times the UF40.241 might also be an option.

23. APPLICATION NOTES

23.1. CHARGING OF BATTERIES

Do not use the power supply to charge batteries.

23.2. SERIES OPERATION

Devices of the same type can be connected in series for higher output voltages. It is possible to connect as many units in series as needed, providing the sum of the output voltage does not exceed 150Vdc. Voltages with a potential above 60Vdc must be installed with a protection against touching.

Avoid return voltage (e.g. from a decelerating motor or battery) which is applied to the output terminals.

Keep an installation clearance of 15mm (left / right) between two power supplies and avoid installing the power supplies on top of each other. Do not use power supplies in series in mounting orientations other than the standard mounting orientation.

Pay attention that leakage current, EMI, inrush current, harmonics will increase when using multiple devices.

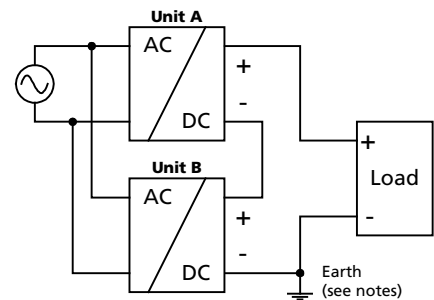

23.3. PARALLEL USE TO INCREASE OUTPUT POWER

Do not use the power supply in parallel to increase the output power.

23.4. PARALLEL USE FOR 1+1 REDUNDANCY

The device can be used to built 1+1 redundant systems.

1+1 Redundancy:

Devices can be paralleled for redundancy to gain higher system availability. Redundant systems require a certain amount of extra power to support the load in case one device fails. The simplest way is to put two devices in parallel. This is called a 1+1 redundancy. In case one device fails, the other one is automatically able to support the load current without any interruption. It is essential to use a redundancy module to decouple devices from each other. This prevents that the defective unit becomes a load for the other device and the output voltage cannot be maintained any more.

1+1 redundancy allows ambient temperatures up to +70°C.

Pay attention that leakage current, EMI, inrush current, harmonics will increase when using multiple devices.

Recommendations for building redundant power systems:

- Use separate input fuses for each device.
- Use separate mains systems for each device whenever it is possible.
- Monitor the individual devices. Therefore, use the DC-OK signal of the device.
- It is desirable to set the output voltages of all devices to the same value ($\pm 100\text{mV}$) or leave it at the factory setting.

Wiring examples:

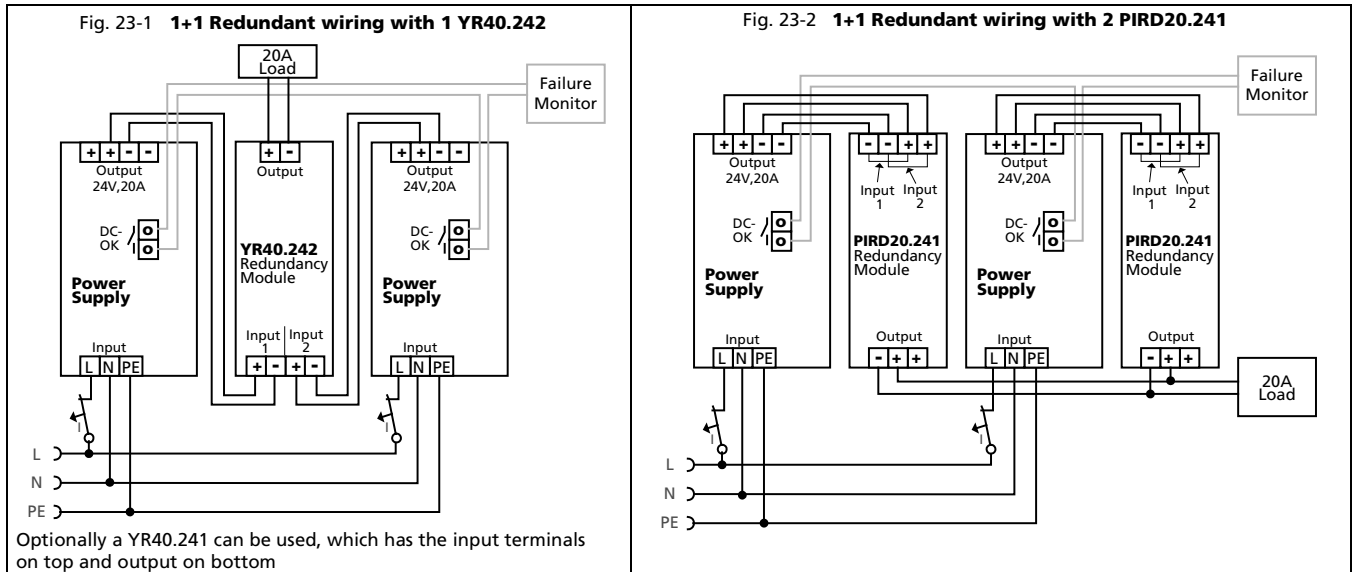

23.5. OPERATION ON TWO PHASES

The power supply can also be used on two-phases of a three-phase-system. Such a phase-to-phase connection is allowed as long as the supplying voltage is below $240V_{+10\%}$.

Ensure that the wire, which is connected to the N-terminal, is appropriately fused.

The maximum allowed voltage between a Phase and the PE must be below 300Vac.

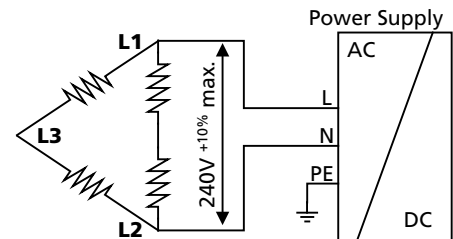

23.6. USE IN A TIGHTLY SEALED ENCLOSURE

When the power supply is installed in a tightly sealed enclosure, the temperature inside the enclosure will be higher than outside. In such situations, the inside temperature defines the ambient temperature for the power supply.

The following measurement results can be used as a reference to estimate the temperature rise inside the enclosure.

The power supply is placed in the middle of the box, no other heat producing items are inside the box

The temperature sensor inside the box is placed in the middle of the right side of the power supply with a distance of 1cm.

The following measurement results can be used as a reference to estimate the temperature rise inside the enclosure.

	Case A	Case B
Enclosure size	180x180x165mm Rittal Typ IP66 Box PK 9519 100, plastic	180x180x165mm Rittal Typ IP66 Box PK 9519 100, plastic
Input voltage	230Vac	230Vac
Load	24V, 16A; (=80%)	24V, 20A; (=100%)
Temperature inside the box	48.3°C	55.3°C
Temperature outside the box	21.0°C	21.0°C
Temperature rise	27.3K	34.3K